

Manual de montagem / Plano de armado

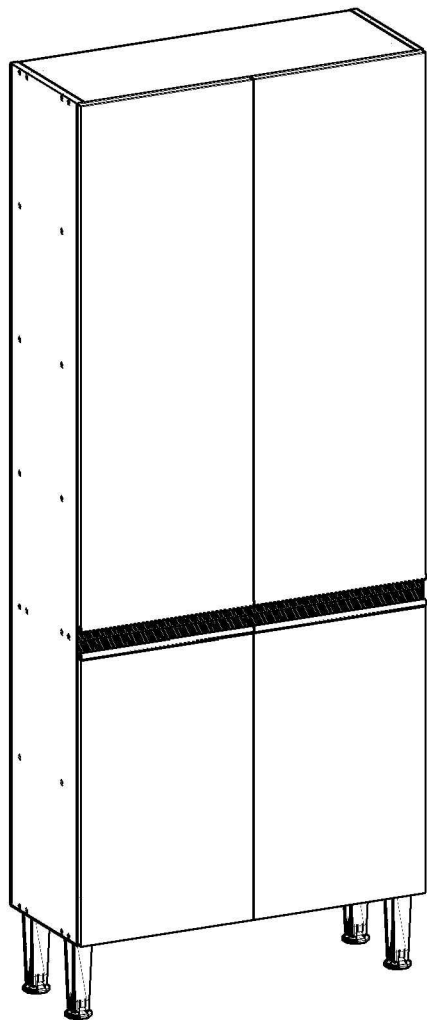

Ref.: 1310M

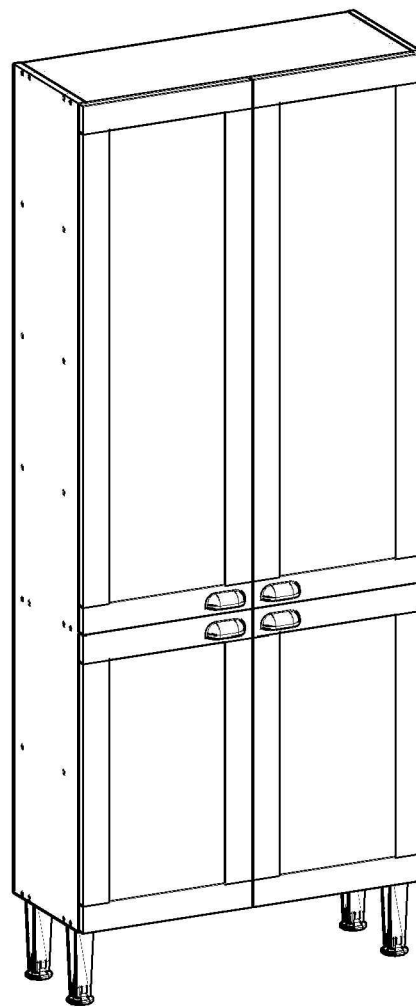

Ref.: 1310P

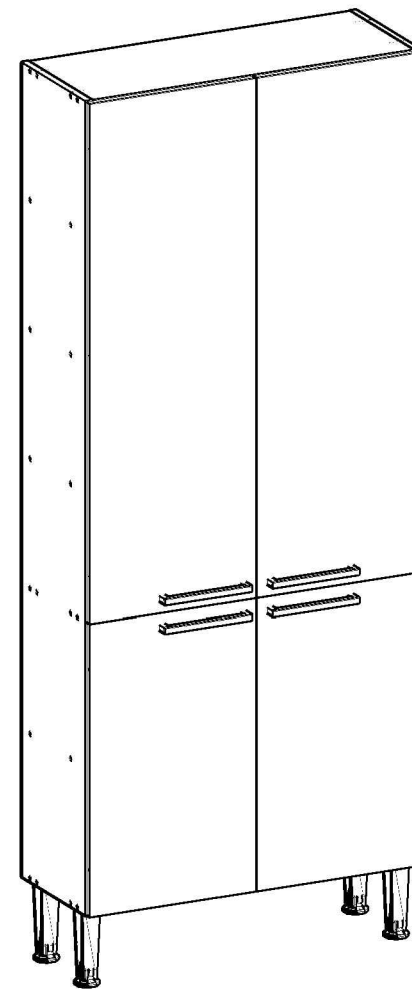

Ref.: 1310L

Parabéns! Você comprou um produto de excelente qualidade, fabricado com chapa de madeira de MDP ou MDF, extraída de florestas renováveis. Possui alta resistência e design atual.

Felicitaciones! Usted compró a un producto de excelente calidad, fabricado con placa de madera de MDP o MDF, proveniente de florestas renovables. Tiene alta resistencia y diseño actual.

Antes de montar o móvel, leia com atenção o manual de montagem!

Antes de armar el mueble, lea con atención el manual de ensamble!



ATENÇÃO:
ATENCIÓN:

1) Verifique todas as peças antes de começar a montagem.

Verifique todas las partes antes de empezar el armado.

2) Ao começar a montagem, não apoie as peças na parede.

Al empezar el armado, no apoyes las partes en la pared.

3) Ao colocar as peças e ferragens de lado, cuidado para não perde-las.

Al poner las piezas y herrages a parte, cuidado para no dañarlas.

4) O móvel deve ser montado no chão, para isso, use a própria caixa para proteger e não danificar o piso.

El mueble suele ser armando al piso, para eso, use la propia caja para protegerlo y no dañar al piso.

5) Comece a montagem seguindo as instruções passo a passo.

Comience el armado siguiendo la instrucciones paso a paso.

6) É de responsabilidade do montador seguir as intrucões desse manual, que são fundamentais para a estrutura do móvel.

Es de responsabilidad del armador seguir las instrucciones de este manual, que son fundamentales para la estructura del mueble.

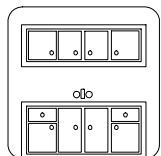

CUIDADOS:
CUIDADOS:

1) A conservação e limpeza deve ser feita com um pano levemente umedecido com água.

La conservación y limpieza debe ser hecha con un trapo levemente humedecido en agua.

2) Não use produtos abrasivos, como saponáceo, detergentes e esponja de aço.

No use productos abrasivos, como saponáceo, detergentes y esponja de acero.

3) Não use cera ou óleo para dar brilho ao móvel.

No use cera o aceites para darle brillo al mueble.



4) Não expor o móvel a interpéries e nem ao calor excessivo.

No exponer el mueble a interperies ni al calor excesivo.

5) Ao terminar a montagem, limpe o ambiente e o móvel.

Al terminar el armado, limpie al ambiente y al mueble.

FERRAMENTAS:
HERRAMIENTAS:

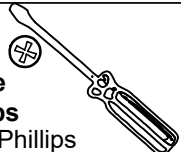
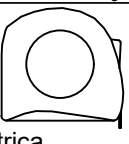





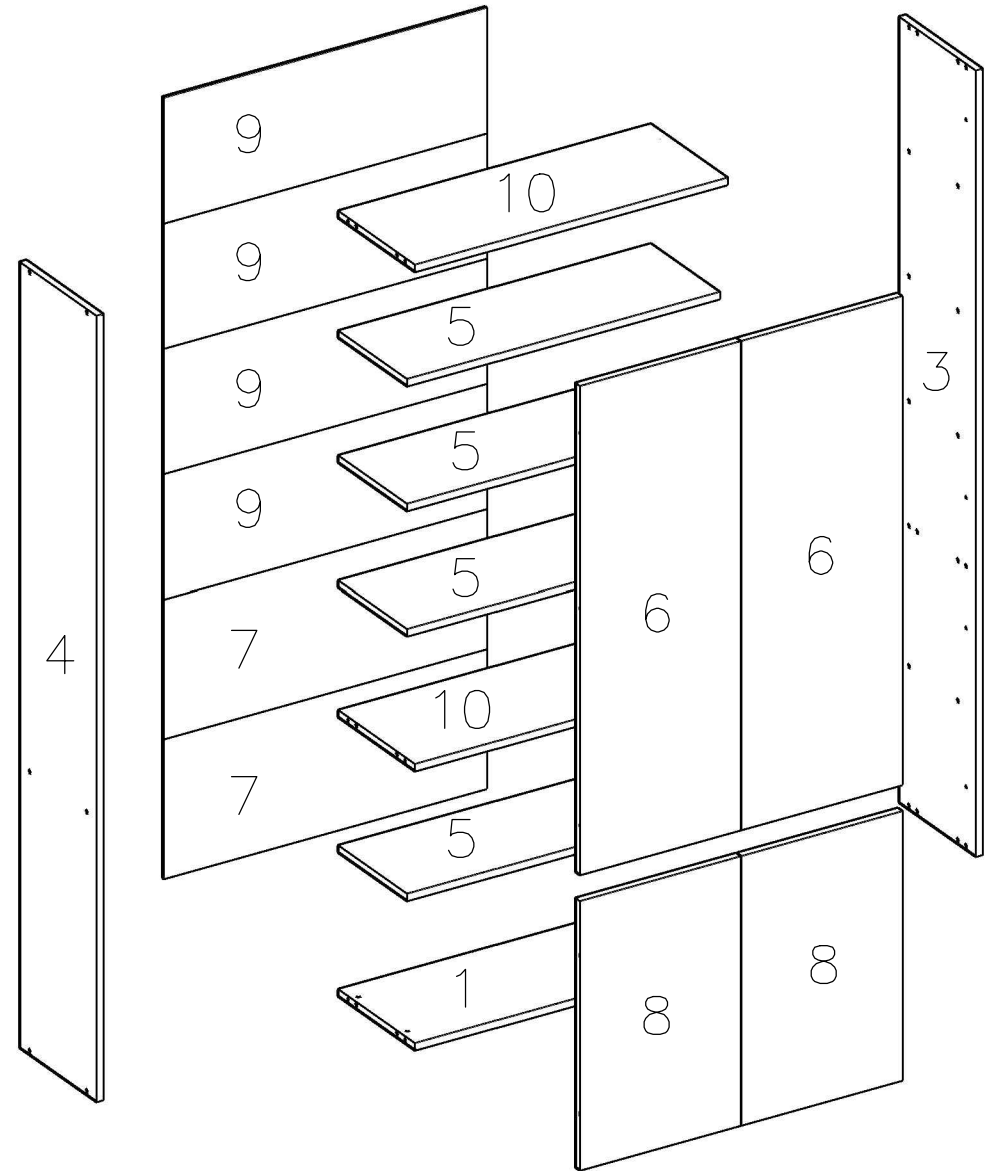



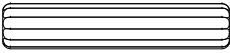

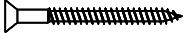

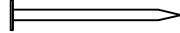
 Parafusadeira Destornillador Eléctrico	 Martelo de borracha Martillo Goma	 Martelo Martillo
	 Chave Phillips Llave Phillips	 Trena Cinta métrica

PEÇAS / PARTS / PIEZAS

Nº No Num	DESCRIÇÃO DESCRIPTION DESCRIPCIÓN	QTD QTY CANT
1	BASE BOTTOM BASE	1
3	LATERAL DIREITA RIGHT SIDE PANEL LATERAL DERECHA	1
4	LATERAL ESQUERDA LEFT SIDE PANEL LATERAL IZQUIERDA	1
5	PRATELEIRA PLATE PANEL REPISA	4
6	PORTA SUPERIOR UPPER DOOR PUERTA SUPERIOR	2
7	COSTA SUPERIOR UPPER BACK PANEL TRASERO SUPERIOR	2
8	PORTA INFERIOR LOWER DOOR PUERTA INFERIOR	2
9	COSTA INFERIOR LOWER BACK PANEL TRASERO INFERIOR	4
10	PRATELEIRA/TAMPO PLATE PANEL/TOP REPISA/TABLERO	2

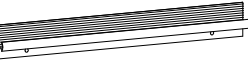

FERRAGENS / HARDWARE / HERRAJES

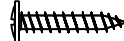
CÓD CODE COD	DESCRIÇÃO DESCRIPTION DESCRIPCIÓN	QTD QTY CANT
A	 CABILHA WOODEN DOWEL TARUGO	12
B	 SUPORTE DE PRATELEIRA SHELF SUPPORT SOPORTE DE ESTANTES	16
C	 PARAFUSO 3,5X40mm SCREW 3,5X40mm TORNILLO 3,5X40mm	12
D	 PARAFUSO 5X50mm SCREW 5X50mm TORNILLO 5X50mm	5
E	 PÉ LEG PATA	4
F	 PREGO NAIL CLAVO	38
G	 GARRA METÁLICA METALLIC CLAW GRAB METALICA	4
I	 PERFIL I INFERIOR LOWER PROFILE I PERFIL I INFERIOR	4
J	 PARAFUSO 4X14mm SCREW 4X14mm TORNILLO 4X14mm	50
K	 SUPORTE DE FIXAÇÃO MOUNTING SUPPORT SOPORTE DE MONTAJE	1
L	 BUCHA PLÁSTICA PLASTIC BUSHING CASQUILLO PLÁSTICO	1
N	 CALÇO PARA DOBRADIÇA HINGE SHED CALZO DE BISAGRA	10
O	 DOBRADIÇA HINGE BIZAGRA	10
P	 PUXADOR PULLER TIRADOR	4
Q	 PARAFUSO 3.5X25mm SCREW 3.5X25mm TORNILLO 3.5X25mm	4
R	 PARAFUSO 3.5X25mm SCREW 3.5X25mm TORNILLO 3.5X25mm	8

UTILIZE A RÉGUA PARA IDENTIFICAR OS PARAFUSOS
USE THE RULER TO IDENTIFY THE SCREWS
UTILICE LA REGLA PARA IDENTIFICAR LOS TORNILLOS



PESO SUPORTADO / WEIGHT SUPPORTED / PESO SOPORTADO



1

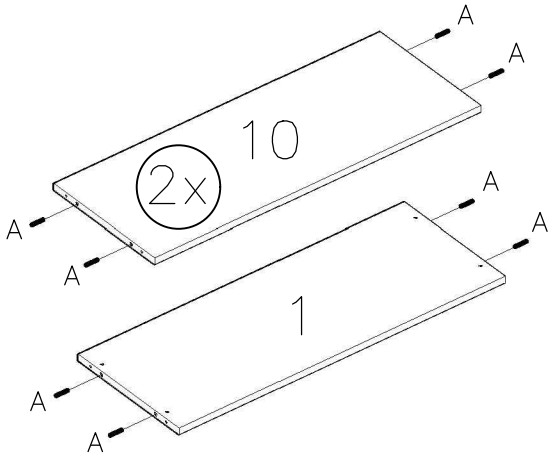

2

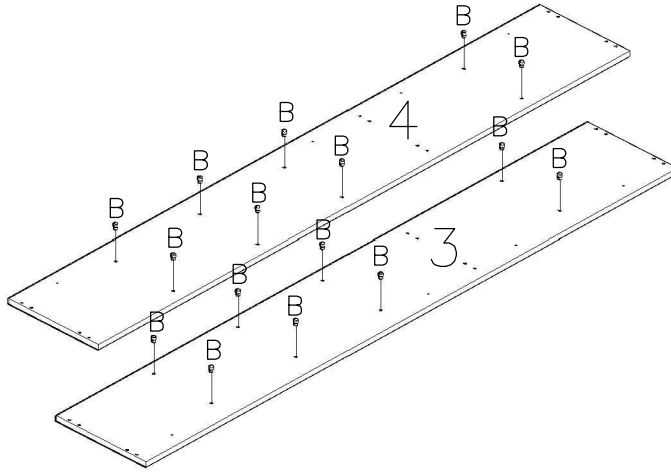

3

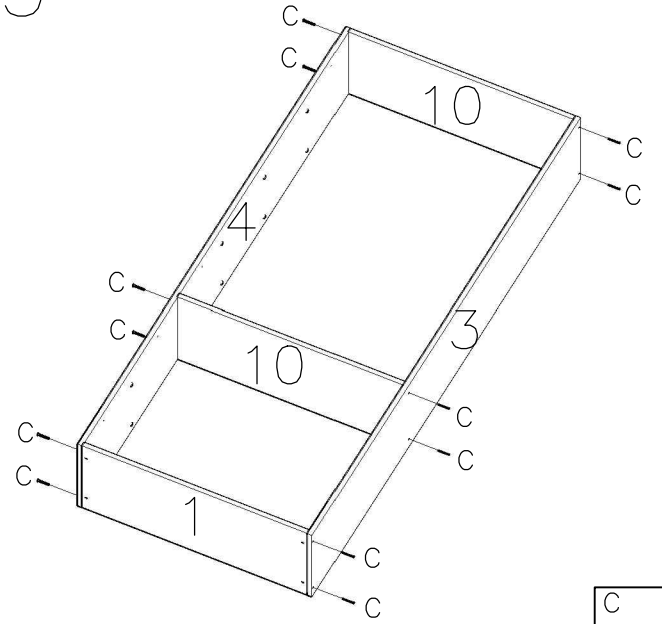

4

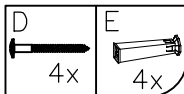
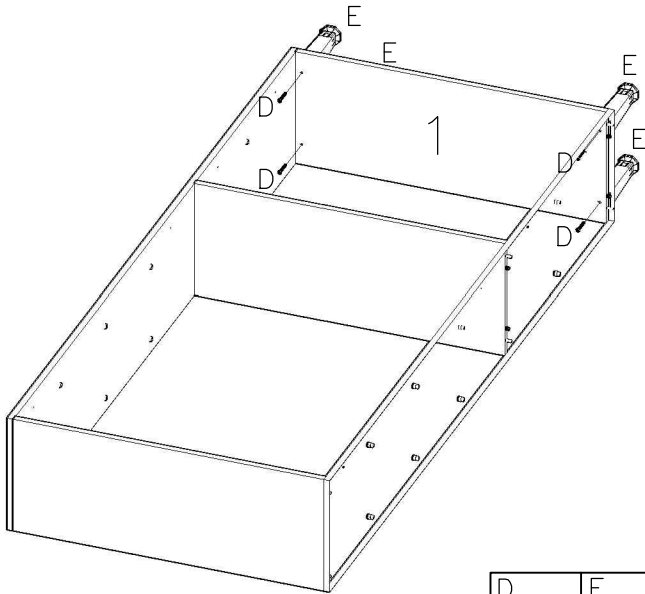

5

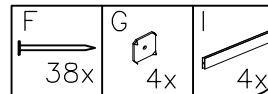
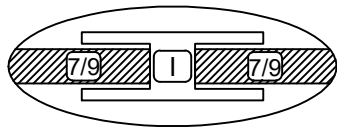
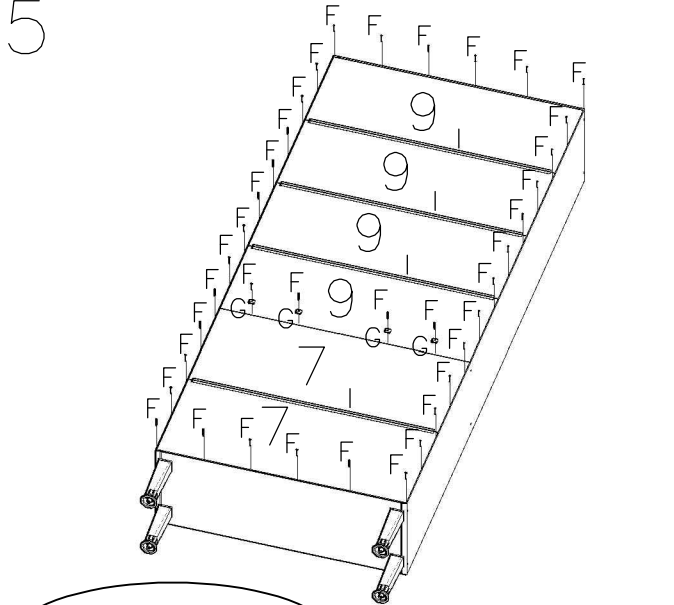

6

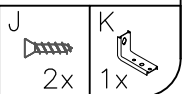
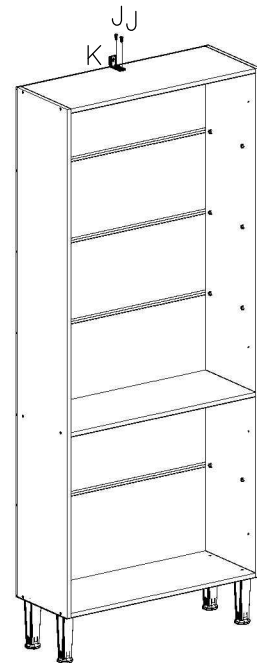

USE A BUCHA DE ACORDO COM O MATERIAL DA PAREDE
 USE LA BUJE DE ACUERDO CON EL MATERIAL DE LA PARED
 USE THE BUSHING ACCORDING TO THE WALL MATERIAL

MATERIAL DA PAREDE: Painei de gesso ou estuque com viga de madeira;
 SISTEMA DE FIXAÇÃO: Parafuso de fixação inserido diretamente na viga de madeira.

WALL MATERIAL: Plaster or stucco panel with wooden beam;
 FIXING SYSTEM: Fixing screw inserted directly into the wooden beam.

MATERIAL DE LA PARED: Panel de yeso o estuco con viga de madera;
 SISTEMA DE FIJACIÓN: Tornillo de fijación insertado directamente en la viga de madera.

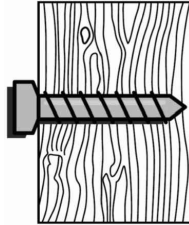

MATERIAL DA PAREDE: Painei de gesso sem viga de madeira;
 SISTEMA DE FIXAÇÃO: Parafuso de fixação com bucha plástica.

WALL MATERIAL: Plaster panel without wooden beam;
 FIXING SYSTEM: Fixing screw with plastic bushing.

MATERIAL DE LA PARED: Panel de yeso sin viga de madera;
 SISTEMA DE FIJACIÓN: Tornillo de fijación con buje de plástico.

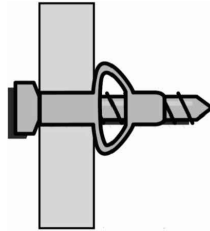

MATERIAL DA PAREDE: Alvenaria (concreto ou tijolo);
 SISTEMA DE FIXAÇÃO: Parafuso de fixação com bucha.

WALL MATERIAL: Masonry (concrete or brick);
 FIXING SYSTEM: Fixing screw with plastic bushing.

MATERIAL DE LA PARED: Albañilería (hormigón o ladrillo);
 SISTEMA DE FIJACIÓN: Tornillo de fijación con buje de plástico.

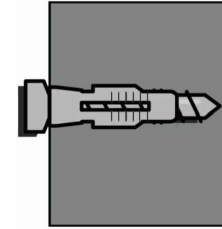

7

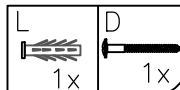
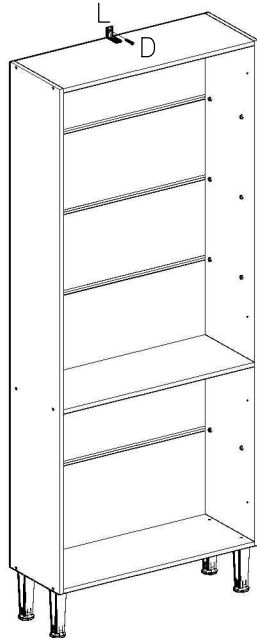

8

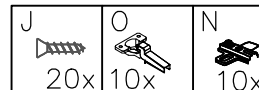
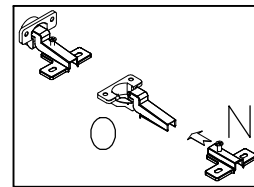
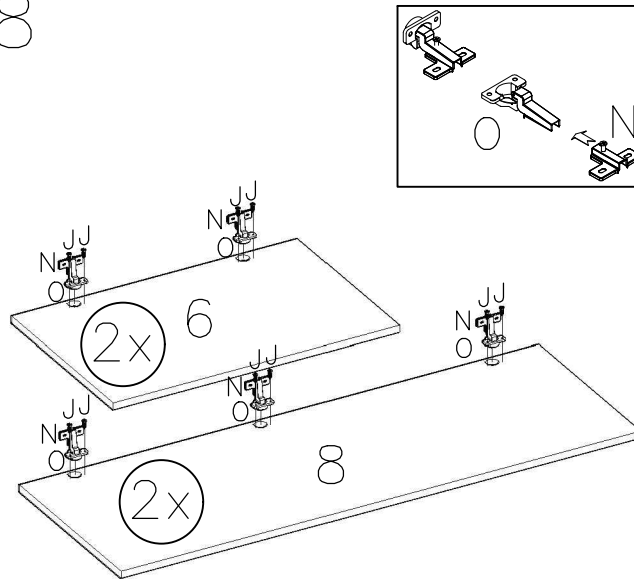

9

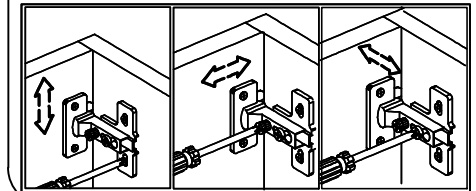
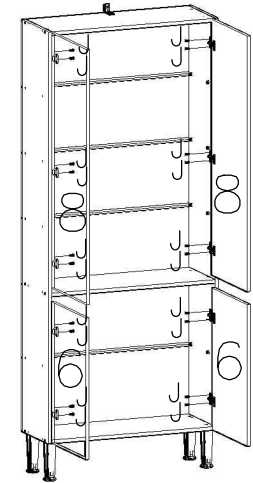

10

Instalação dos puxadores conforme modelo adquirido, siga os passos no manual dos puxadores.

Instalación de las manijas según el modelo adquirido, seguir los pasos del manual de manijas.

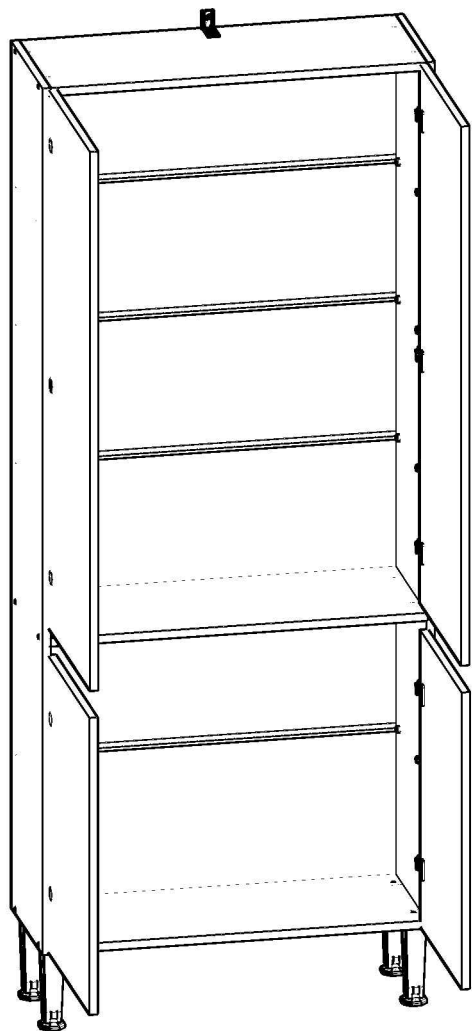

11

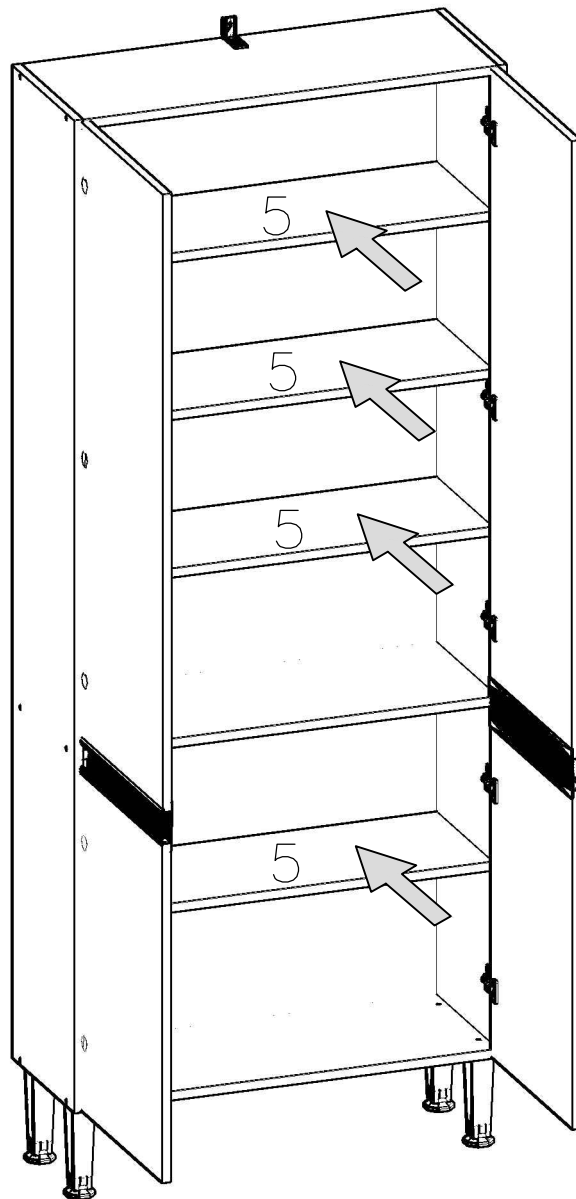

12

