

MANUAL DE MONTAGEM / ASSEMBLY INSTRUCTIONS / PLANO DE ARMADO

Antes de montar o móvel, leia com atenção o manual de montagem!
Before assembling the furniture, carefully read the assembly instructions!
Antes de armar el mueble, lea con atención el manual de ensamble!



Ref.: 0816B

genialflex
ambientes incríveis para todos

Parabéns! Você comprou um produto de excelente qualidade, fabricado com chapa de madeira de MDP ou MDF, extraída de florestas renováveis. Possui alta resistência e design atual.

Congratulations! You have purchased a product of excellent quality, made from MDP or MDF wood veneer, extracted from renewable forests. It has high strength and current design.

Felicitaciones! Usted compró a un producto de excelente calidad, fabricado con placa de madera de MDP o MDF, proveniente de florestas renovables. Tiene alta resistencia y diseño actual.



ATENÇÃO
ATTENTION
ATENCIÓN

1) Verifique todas as peças antes de começar a montagem.

Check all parts before starting assembly.

Verifique todas las partes antes de empezar el armado.

2) Ao começar a montagem, não apoie as peças na parede.

When starting the assembly, do not support the parts on the wall.

Al empezar el armado, no apoyes las partes en la pared.

3) Ao colocar as peças e ferragens de lado, cuidado para não perde-las.

When placing parts and hardware aside, be careful not to lose them.

Al poner las piezas y herrages a parte, cuidado para no dañarlas.

4) O móvel deve ser montado no chão, para isso, use a própria caixa para proteger e não danificar o piso.

The furniture must be mounted on the floor, to do this, use the box itself to protect and not damage the floor.

El mueble suele ser armado al piso, para eso, use la propia caja para protegerlo y no dañar al piso.

5) Comece a montagem seguindo as instruções passo a passo.

Begin assembly by following the step-by-step instructions.

Comience el armado siguiendo la instrucciones paso a paso.

6) É de responsabilidade do montador seguir as intruções desse manual, que são fundamentais para a estrutura do móvel.

It's the assembler's responsibility to follow the instructions in this manual, which are fundamental to the structure of the furniture.

Es de responsabilidad del armador seguir las instrucciones de este manual, que son fundamentales para la estructura del mueble.

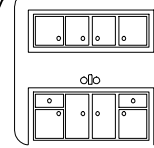

CUIDADOS
CARE
CUIDADO

1) A conservação e limpeza deve ser feita com um pano levemente umedecido com água.

Care and cleaning should be done with a cloth slightly moistened with water.

La conservación y limpieza debe ser hecha con un trapo levemente humedecido en agua.

2) Não use produtos abrasivos, como saponáceo, detergentes e esponja de aço.

Do not use abrasive products, such as soap, detergents and steel sponge.

No use productos abrasivos, como saponáceo, detergentes y esponja de acero.

3) Não use cera ou óleo para dar brilho ao móvel.

Do not use wax or oil to shine the furniture.

No use cera o aceites para darle brillo al mueble.

4) Não expor o móvel a interpéries e nem ao calor excessivo.

Do not expose the furniture to weather or excessive heat.

No exponer el mueble a interperies ni al calor excesivo.

5) Ao terminar a montagem, limpe o ambiente e o móvel.

When the assembly is finished, clean the room and the furniture.

Al terminar el armado, limpie al ambiente y al mueble.

FERRAMENTAS / TOOLS / HERRAMIENTAS



MARTELO
HAMMER
MARTILLO



MARTELO DE BORRACHA
RUBBER HAMMER
MARTILLO GOMA



CHAVE PHILLIPS
PHILLIPS SCREWDRIVER
LLAVE PHILLIPS









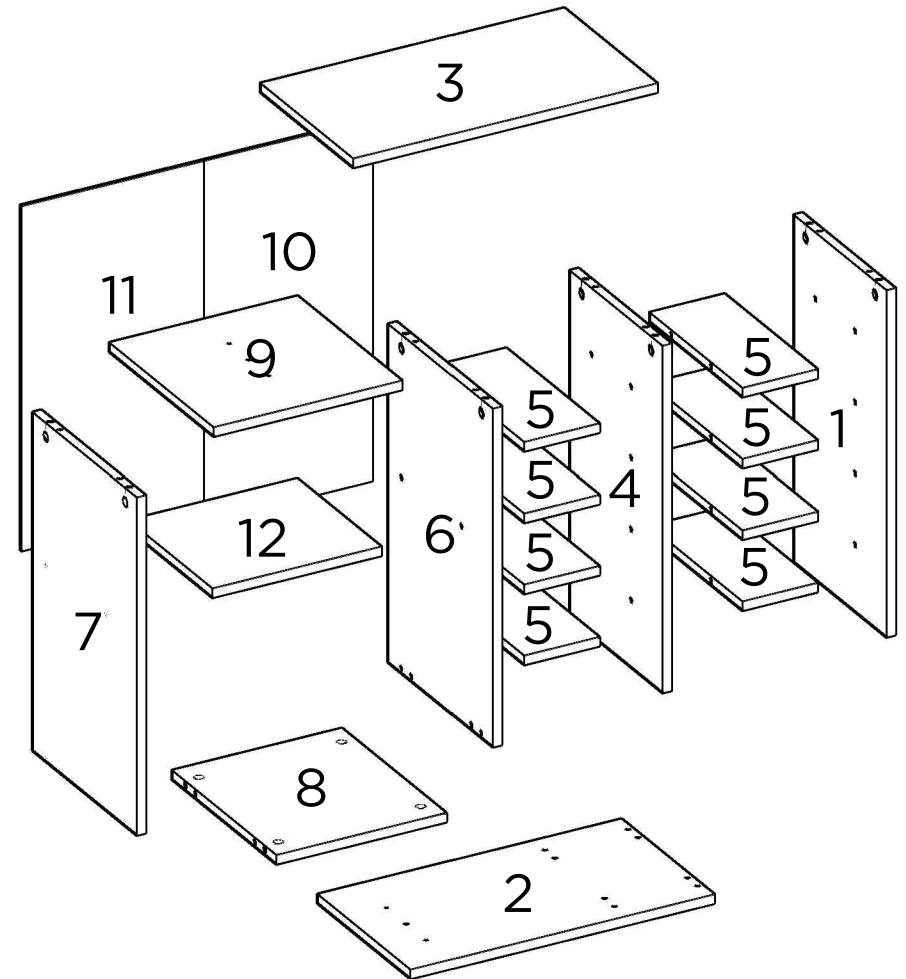



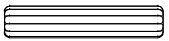

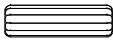
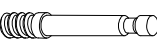



TRENA
MEASURING TAPE
CINTA MÉTRICA

PEÇAS / PARTS / PIEZAS

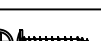
Nº No Num	DESCRIÇÃO DESCRIPTION DESCRIPCIÓN	QTD QTY CANT	COMP LGTH LARG (mm)	LARG WDTH ANCH (mm)	ESP DPTH GROS (mm)
1	LATERAL DIREITA RIGHT SIDE PANEL LATERAL DERECHA	1	604	298	15
2	BASE BOTTOM BASE	1	540	298	15
3	TAMPO TOP TABLERO	1	540	298	15
4	DIVISÓRIA ADEGA CELLAR DIVISION DIVISIÓN ADEGA	1	604	298	15
5	BASE ADEGA CELLAR BOTTOM BASE ADEGA	8	133	298	15
6	LATERAL DIREITA NICHO RIGHT SIDE NICHE NICHO LADO DERECHO	1	589	335	15
7	LATERAL ESQUERDA LEFT SIDE PANEL LATERAL IZQUIERDA	1	589	335	15
8	BASE NICHO NICHE BOTTOM BASE NICHO	1	302	335	15
9	TAMPO NICHO NICHE TOP TABLERO NICHO	1	335	335	15
10	COSTA ADEGA CELLAR BACK PANEL TRASERO ADEGA	1	630	300	3
11	COSTA NICHO NICHE BACK PANEL TRASERO NICHO	1	600	323	3
12	PRATELEIRA PLATE PANEL REPISA	1	300	267	15

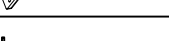

FERRAGENS / HARDWARE / HERRAJES

CÓD CODE COD	DESCRIÇÃO DESCRIPTION DESCRIPCIÓN	QTD QTY CANT
A	 CAVILHA 6X30mm WOODEN DOWEL 6X30mm TARUGO 6x30mm	32
B	 CAVILHA 6X50mm WOODEN DOWEL 6X50mm TARUGO 6x50mm	8
C	 CAVILHA 6X15mm WOODEN DOWEL 6X15mm TARUGO 6x15mm	2
D	 PARAFUSO MINIFIX MINIFIX SCREW TORNILLO MINIFIX	12
E	 ARRUELA DE SILICONE SILICONE WASHER ARRUELA DE SILÍCIO	1
F	 PUXADOR HANDLE TIRADOR	1
G	 (DOBRADICA) (HINGE) (BISAGRA) CALÇO DE DOBRADIÇA HINGE SHED CALZO DE BISAGRA	2
H	 (DOBRADICA) (HINGE) (BISAGRA) DOBRADIÇA HINGE BISAGRA	2
I	 PARAFUSO 3,5X20mm SCREW 3,5X20mm TORNILLO 3,5X20mm	1
J	 (DOBRADICA) (HINGE) (BISAGRA) PARAFUSO DE PLÁSTICO PLASTIC SCREW TORNILLO PLÁSTICO	4
K	 TAMBOR MINIFIX MINIFIX DRUM TAMBOR MINIFIX	12
L	 PARAFUSO 3,5X40mm SCREW 3,5X40mm TORNILLO 3,5X40mm	4
M	 PARAFUSO 3,5X25mm SCREW 3,5X25mm TORNILLO 3,5X25mm	4
N	 PARAFUSO 4X16mm SCREW 4X16mm TORNILLO 4X16mm	16
O	 PÉ LEG PATA	4
P	 PREGO NAIL CLAVO	23
Q	 GARRA METÁLICA METALLIC CLAW GRAB METALICA	3
R	 SUPORTE DE PRATELEIRA SHELF SUPPORT SOPORTE DE ESTANTES 6mm	4
S	 BATENTE DE PORTA KNOCKER BATENTE DE LA PUERTA 8mm	1
T	 PARAFUSO 4X14mm SCREW 4X14mm TORNILLO 4X14mm	4

UTILIZE A RÉGUA PARA IDENTIFICAR OS PARAFUSOS
USE THE RULER TO IDENTIFY THE SCREWS
UTILICE LA REGLA PARA IDENTIFICAR LOS TORNILLOS



PESO SUPORTADO / WEIGHT SUPPORTED / PESO SOPORTADO

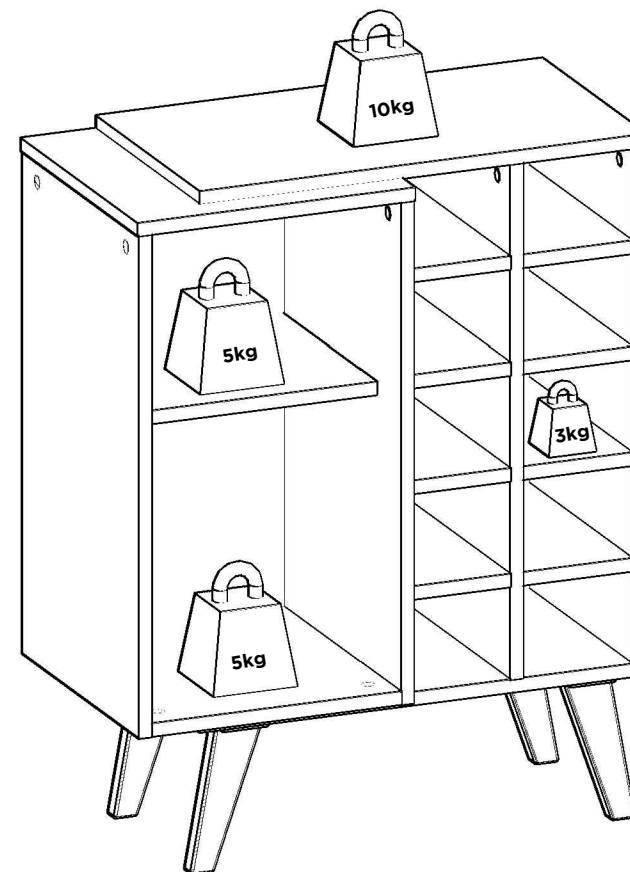

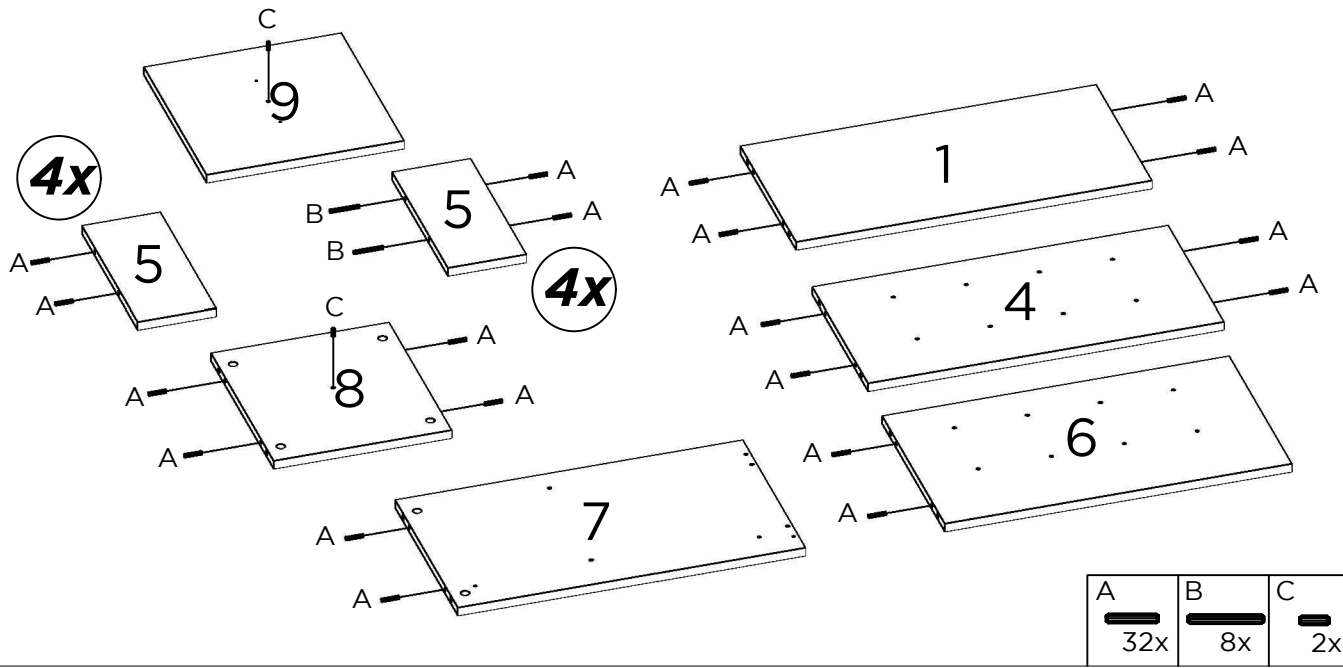
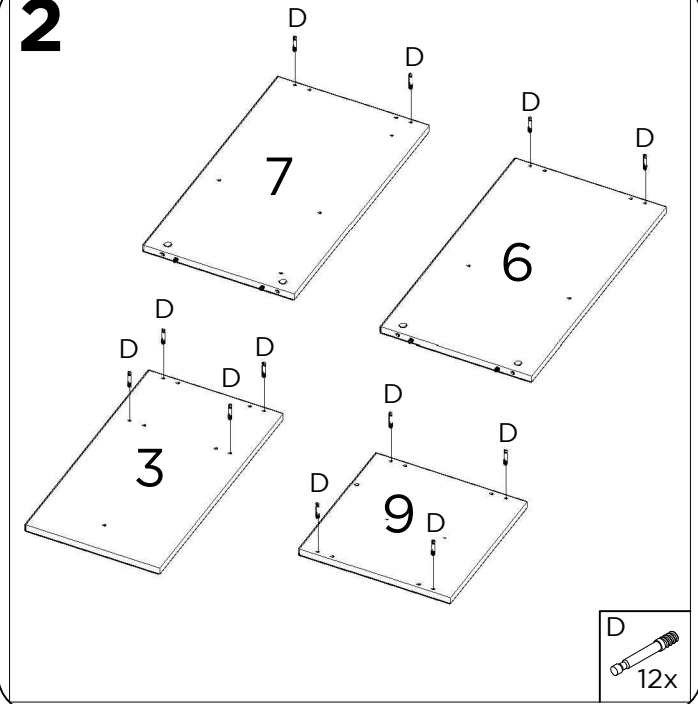
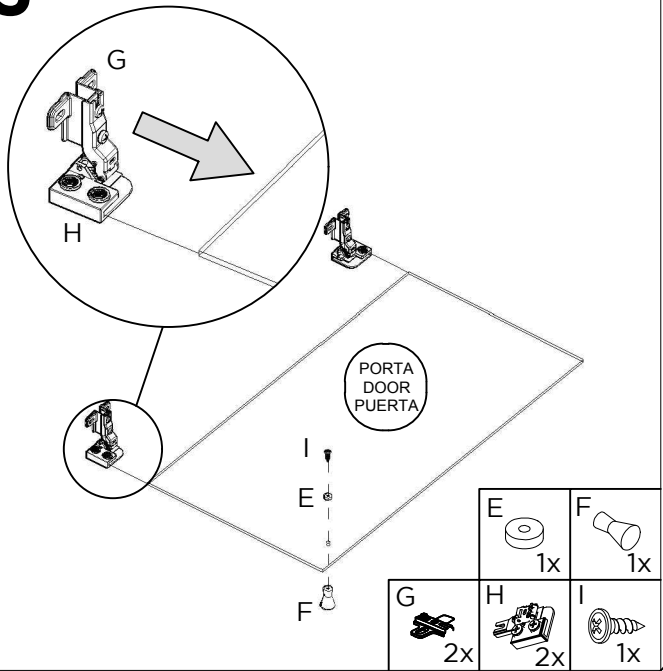
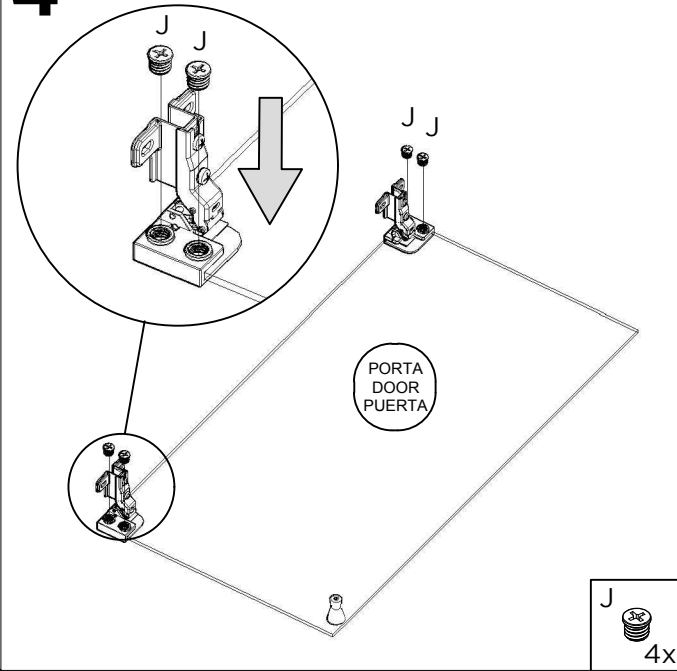
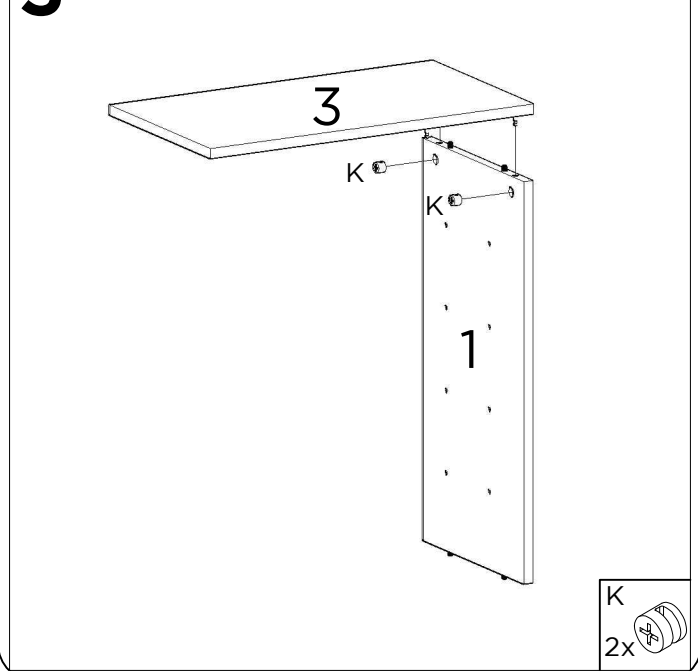
1**2****3****4****5**

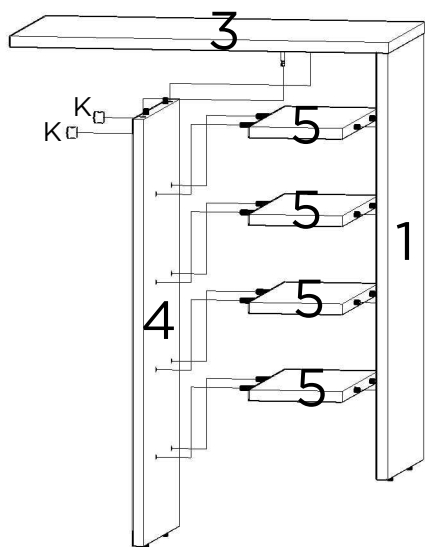
6

K
2x

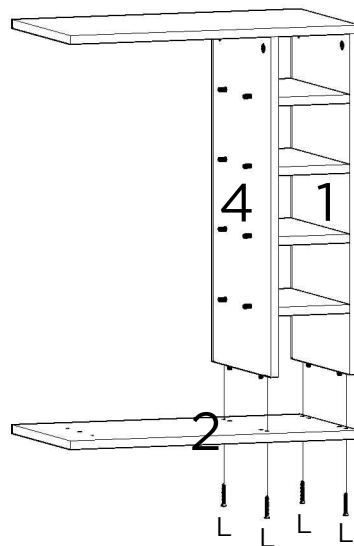
7

L
4x

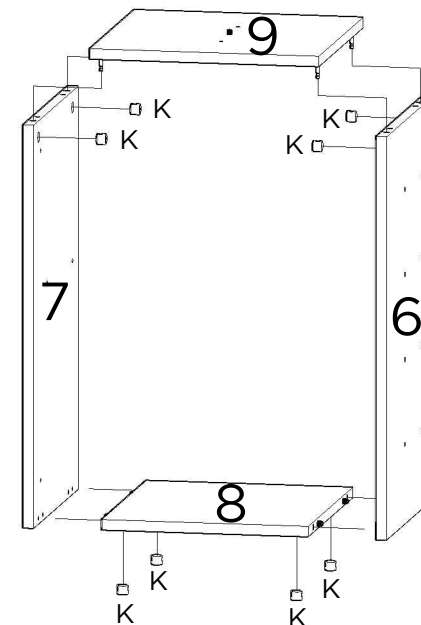
8

K
8x

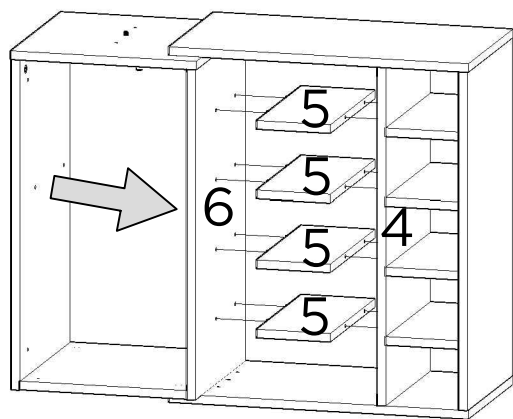
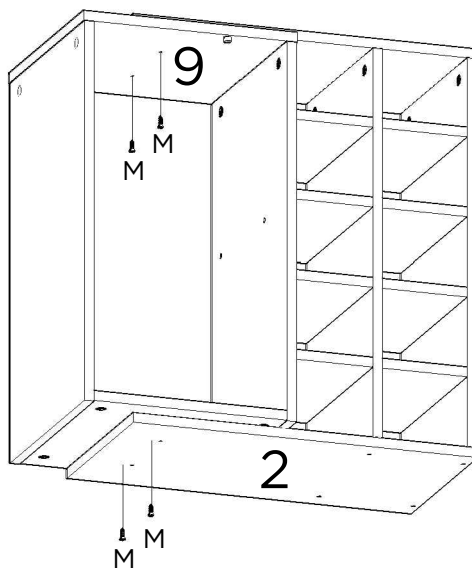

9**10**

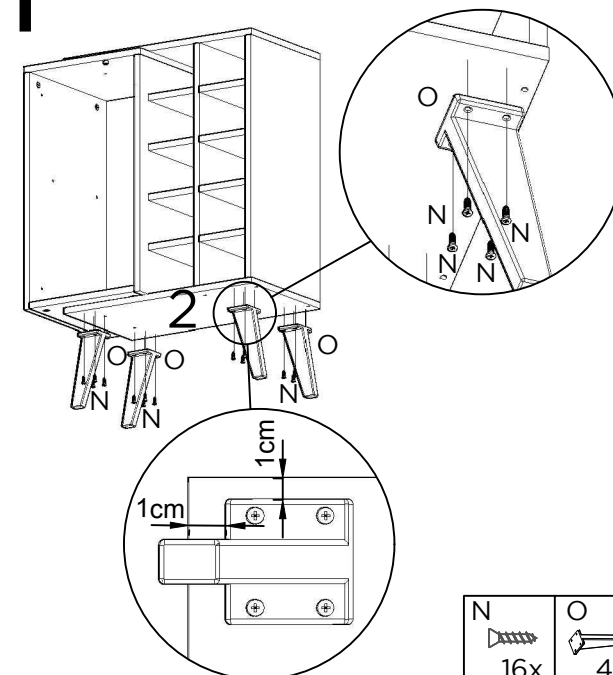
M
4x



11

N
16x

O
4x

12

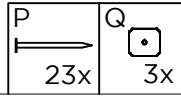
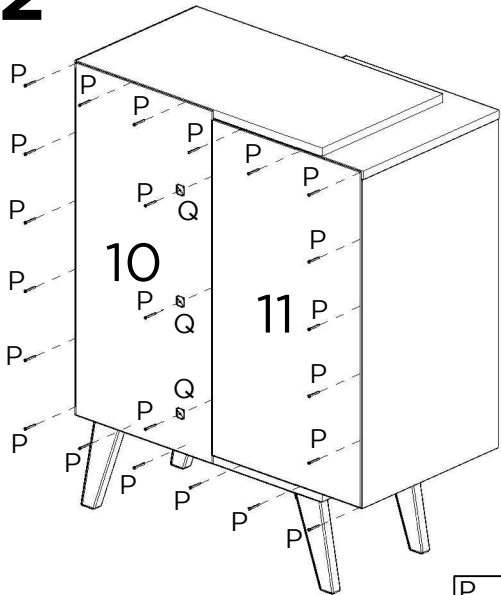

13

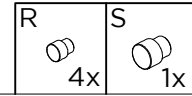
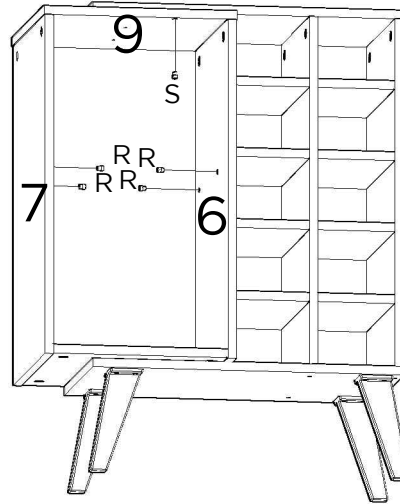

14

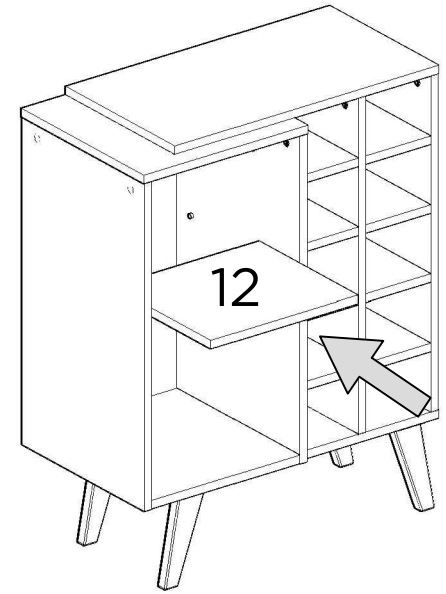

15

